

# enea

News & Features 2020

At Enea we research, develop and produce furniture in our factory in the Basque Country, Spain. We collaborate with prestigious designers to develop products with character. Applying new technologies, we are able to elaborate strong, sophisticated and sustainable furniture. In 2020 we keep creating new collections and developing our products to offer a integrate solutions to the market.

*En Enea investigamos, desarrollamos y producimos mobiliario en nuestra fábrica del País Vasco, España. Con objeto de desarrollar productos con caracter, colaboramos con diseñadores de prestigio. Aplicando nuevas tecnologías, somos capaces de elaborar muebles fuertes, sofisticados y sostenibles. En 2020 seguimos creando nuevas colecciones y desarrollando nuestros productos para ofrecer soluciones integrales al mercado.*





Kubika  
4

Noa  
12

Lottus Wood  
20

Kaiak  
28

Ema  
36

Features  
44

# Kubika

4

Estudi Manel Molina

Kubika is a modular seating system that allows to create unlimited configurations through individual modules and accessories that are easily assembled. Its versatility and sophisticated design with simple lines allow adapting to any environment and need.

*Kubika es un sistema de asientos modulares que permite crear configuraciones ilimitadas a través de módulos y accesorios individuales fácilmente ensamblables. Su versatilidad y su diseño sofisticado de líneas sencillas permiten que pueda adaptarse a cualquier entorno y necesidad.*



5

Some Kubika modular seating system ensemble options.



6

Kubika in Kvadrat Divina Melange 3 0617 on RAL 7016 Anthracite frame.



7

Kubika 4 places in Kvadrat Divina Melange 3 0571, oak table top 90° union on Pantone 7545 Ocean frame.

8

9





## Kubika

Kubika system includes different modules that can be combined in several configurations. It consists of seats with or without backrest, intermediate arms and table dividers. All the seats can be upholstered in all range of finishes and they are placed in a lacquered steel frame connected on different aluminum legs.

*El sistema Kubika se compone de módulos que pueden ser combinados en distintas configuraciones. Consta de asientos modulares con o sin respaldo, brazos intermedios y mesas divisoras. Todos los asientos son tapizables en toda gama de acabados y se colocan en un marco de acero lacado conectado con diferentes patas de aluminio.*

### Products

Kubika 4 places with intermediate table top

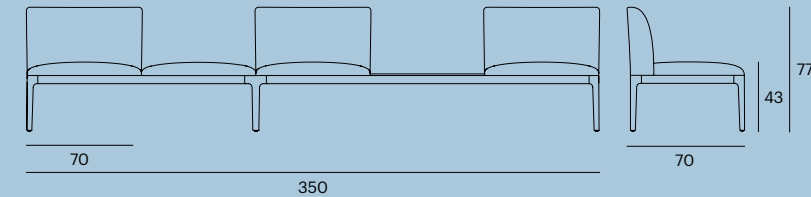

Kubika 2 places with intermediate table top

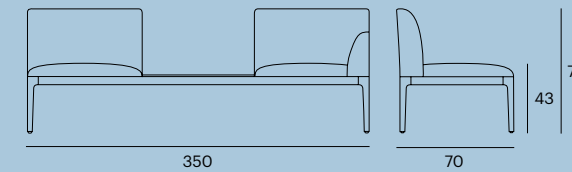

### Seat-backrest

- Birch plywood with recyclable foam upholstered in all materials

### Asiento-respaldo

- Tapizables en todos los materiales sobre madera abedul en espuma reciclable

### Frame

- Laminated steel tube frame with union cast aluminium legs

### Estructura

- Estructura laminada de tubo laminado de acero con patas de unión de aluminio inyectado

### Accessories

- Intermediate upholstered arms on recyclable foam  
- FSC-certified laminated oak wood veneer union top table 45°/90°  
- Filter feet

### Accesorios

- Brazos intermedios tapizados en espuma reciclable  
- Madera roble de chapa laminada con certificado FSC mesa unión 45°/90°  
- Pies de fieltro

### Certificates

- Satisfactory results according norm UNE-EN 16139:2013  
- Fabrics/leathers materials: check materials' technical characteristics  
- Laminated oak wood veneer with FSC certificate  
- Optional varnish for fireproof

### Certificados

- Resultados satisfactorios según norma UNE-EN 16139:2013  
- Telas/cueros: Chequear especificaciones técnicas de materiales  
- Láminas de chapa de abedul con certificado FSC  
- Opcional barnizado ignifugo

### Weight-volume

Product	Weight	Volume Box 1	Volumne Box 2	Units/Box	Weight Box 1	Weight Box 2	Heat Load
Kubika 2 places	15 kg	80×100×130 cm	-	1	15.6 Kg	-	15,68 MJ
Kubika 3 places	18.12 kg	80×100×200 cm	-	1	18.72 kg	-	18.8 MJ
Kubika 5 places	28.94 kg	80×100×130 cm	80×100×200 cm	1	18.13 kg	10.81 kg	29.96 MJ
Kubika 6 places	32.94 kg	80×100×200 cm	80×100×200 cm	1	18.13 kg	14.81 kg	33.96 MJ
Seat	4.1 kg	72×72×50 cm	-	3	12.9 kg	-	82.075 MJ
Seat and back	6.6 kg	72×72×50 cm	-	2	13.8 kg	-	31.15 MJ
Seat and back with arm	8.4 kg	72×72×50 cm	-	1	9 kg	-	159.1 MJ
Top table	5.6 kg	72×72×1.5 cm	-	1	6.2 kg	-	108.25 MJ

# Noa

12

Estudi Manel Molina

The Noa collection is part of a contemporary version of the classic Bistro chair. It is made of lightweight and robust materials that allow and facilitate its stackability, manageability and resistance. Its modern design and friendly lines make it an iconic object and the variety of its finishes allows to be adaptable to all kinds of domestic or hospitality spaces.

*La colección Noa parte de una versión contemporánea de la clásica silla Bistro. Está fabricada en materiales ligeros y robustos que permiten y facilitan su apilabilidad, manejabilidad y resistencia. Su diseño moderno y de líneas amables hacen de ella un objeto icónico y la variedad de sus acabados permiten que se adapte a todo tipo de espacios domésticos o de restauración.*



13



Noa chair seat pad in RAL 7004 Grey assembled in RAL 9005 Black on birch frame.



Stackability: Noa in Pantone 5753 Olive on birch frame.



Seat and back finish options: Seat in Kvadrat Remix 2 113 on on black stained birch frame. Seat pad Pantone 7545 Ocean on RAL 9005 Black seat and back, on birch frame. Seat and back in Pantone 533 Navy Blue on birch frame. Seat pad Kvadrat Remix 2 393 on RAL 9005 with black seat and back on birch frame.



Noa High stool and chair in RAL 9016 White on birch frame.



Frame options: Noa in RAL 9005 Black, seat pad in Kvadrat Remix 2 0173 on black stained birch frame and Noa in RAL 9005 Black, seat pad in Pantone 7545 Ocean on birch frame.



## Noa

Noa features a laminated frame made of natural birch with a direct union to the polypropylene to improve its flexibility. The collection consists on a narrow chair for tight spaces, stackable chair for storage and two stools of 65 and 75 cm height. The seat and backrest can be customized in single-color polypropylene, in different color seat pad polypropylene or upholstered and fully upholstered option.

*La silla Noa está construida con una estructura de madera laminada de chapa de abedul con unión directa al Polipropileno para mejorar su flexibilidad. La colección consta de silla estrecha para espacios reducidos, silla apilable y dos alturas de taburetes 65 y 75 cm. El asiento y el respaldo pueden tener distintos acabados: en polipropileno monocolor, con asiento pad de polipropileno de color o tapizable y completamente tapizados.*

### Products

#### Noa chair

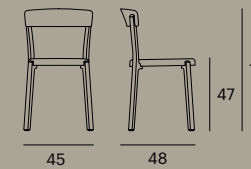

#### Noa stackable chair

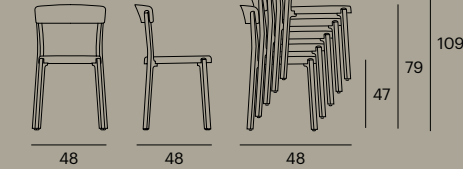

#### Noa medium stool

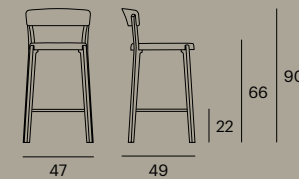

#### Noa high stool

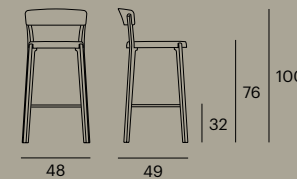

### Seat-backrest

- Recyclable polypropylene
- Upholstered in all materials on recyclable foam

### Asiento-respaldo

- Polipropileno reciclable
- Tapizable en todos los materiales en espuma reciclable

### Frame

- FSC-certified birch laminated wood veneer with direct structure binding to polypropylene to improve the set flexibility
- Footrest stool: Stainless steel tube (available from August, before in bright chromed steel tube)

### Estructura

- Madera abedul de chapa laminada con certificado FSC con unión de estructura directo al polipropileno para mejorar la flexibilidad del conjunto
- Reposapiés del taburete: Acero inoxidable (disponible a partir de Agosto, antes en tubo de acero cromado)

### Accessories

- Filter feets

### Accesorios

- Pies de fieltro

### Certificates

- Satisfactory results according norm UNE-EN 16139:2013
- Laminated birch wood veneer with FSC certificate
- Optional varnish for fireproof
- Optional fireproof polypropylene according norm M2
- Optional ultraviolet polypropylene additive for outdoor
- Fabrics/leathers materials: check materials' technical characteristics

### Certificados

- Resultados satisfactorios según norma UNE-EN 16139:2013
- Madera abedul de chapa laminada con certificado FSC
- Opcional barnizado ignifugo
- Opcional polipropileno ignifugo según norma M2
- Opcional polipropileno ultravioleta para exterior
- Telas/cueros: Chequear especificaciones técnicas de materiales

### Weight-volume

Product	Weight	Volume	Units/Box	Weight/Box	Units Stackable	Units/Trolley	Heat Load
Noa chair	4.2 kg	65x48x100 cm	2	9 kg	-	-	110.41 MJ
Noa stackable chair	4.38 kg	65x48x100 cm	3	13.74 kg	5	-	110.63 MJ
Noa medium stool	5.55 kg	53x49x103 cm	1	6.15 Kg	-	-	114.95 MJ
Noa high stool	5.75 kg	53x49x103 cm	1	6.35 Kg	-	-	118.50 MJ

# Lottus Wood

20

Lievore Altherr Molina

The Lottus Wood family features a new spin foot design made of oak wood. The new frame can be attached to the Lottus and Lottus High shells and incorporate oak wooden armrests as an accessory. Its incorporation brings warmth, lightness and comfort to the family, making it the ideal choice for soft office and hospitality spaces.

*La familia Lottus Wood incorpora un nuevo diseño de patas spin fabricado en madera de roble. La nueva estructura puede acoplarse a las carcasas Lottus y Lottus High e incorporar como accesorio los reposabrazos de madera de roble. Su incorporación aporta calidez, ligereza y confort a la familia, convirtiéndola en la opción idónea para espacios soft office y hospitality.*



21

Lottus Spin RAL 7032 Sand, Lottus Wood Spin on oak frame, Lottus Confident Pantone 5753 Olive and Lottus Confident RAL 7016 Anthracite on wheels.

22

23



Lottus Wood Spin on oak and black stained oak frames.



Lottus Wood Spin with seat pad upholstered in Kvadrat Divina Melange 220 on black stained oak and oak frames with arms.





## Lottus Wood Spin

The Lottus Wood Spin chair is developed with a fixed oak foot being the perfect addition to the Lottus Wood as well as Lottus as Lottus High collections. It can be completed with plastic, wood or even upholstered shells and the option of incorporating same finish oak plywood arms.

*La silla Lottus Wood Spin está desarrollada con una pata fija de madera de roble que la hacen el complemento perfecto tanto para la colección Lottus Wood como Lottus y Lottus High. Pueden combinarse con carcasas de plástico, madera o tapizadas y ofrece la opción de incorporar brazos de madera de roble contrachapados del mismo acabado.*

### Products

Lottus Wood spin

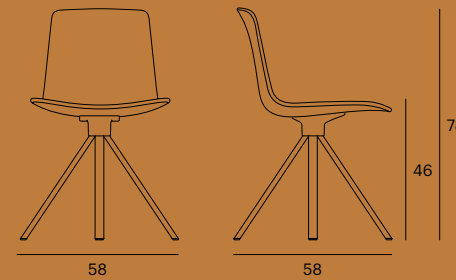

Lottus Wood spin with arms

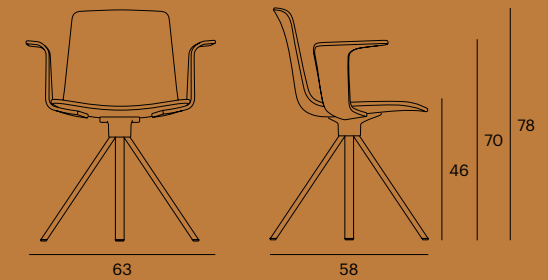

Lottus Wood High spin

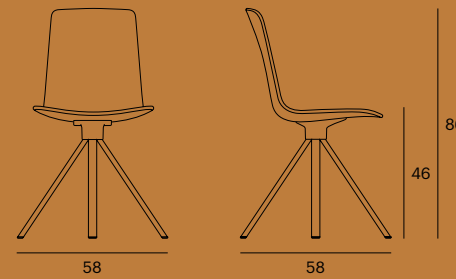

Lottus Wood High spin with arms

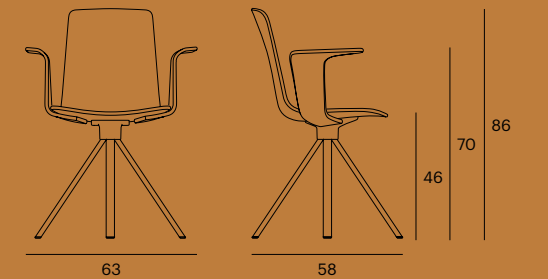

### Shell

- Recyclable polypropylene
- Upholstered in all materials on recyclable foam
- FSC-certified laminated oak wood veneer

### Carcasa

- Polipropileno reciclable
- Tapizable en todos los materiales en espuma reciclable
- Madera roble chapa laminada con certificado FSC

### Frame

- FSC-certified oak wood on cast aluminium union

### Estructura

- Madera roble certificado FSC en unión de aluminio inyectado

### Accessories

- Filter feet

### Accesorios

- Pies de fieltro

### Certificates

- Satisfactory results according norm UNE-EN 16139:2013
- Laminated veneer and wood in Oak with FSC certificate
- Optional varnish for fireproof
- Optional fireproof polypropylene according norm M2
- Optional ultraviolet polypropylene additive for outdoor
- Fabrics/leathers materials: check materials' technical characteristics

### Certificados

- Resultados satisfactorios según norma UNE-EN 16139:2013
- Chapa laminada y madera roble con certificado FSC
- Opcional barnizado ignífugo
- Opcional polipropileno ignífugo según norma M2
- Opcional polipropileno ultravioleta para exterior
- Telas/cueros: Chequear especificaciones técnicas de materiales

### Weight-volume

Product	Weight	Volume	Units/Box	Weight/Box	Units Stackable	Units/Trolley	Heat Load
Lottus Wood spin	4.28 kg	65×48×100 cm	2	9.2 kg	-	-	67.59 MJ
Lottus Wood spin with arms	5 kg	65×57×95 cm	1	5.6 kg	-	-	83.75 MJ

# Kaiak

28

Estudi Manel Molina

The Kaiak family features a new spin foot design made of oak wood. The new frame is compatible with the entire collection of the chair or lounge format and works especially well with the wooden shell and upholstery combination. A new update for the family that brings warmth and comfort for soft office or hospitality spaces.

*La familia Kaiak incorpora un nuevo diseño de patas spin fabricado en madera de roble. La nueva estructura es compatible con toda la colección en formato silla o lounge y funciona especialmente bien con la combinación de carcasa de madera y tapizado. Una nueva actualización para la familia que aporta calidez y confort para espacios soft office u hospitality.*



29



Kaiak Spin Wood seat upholsterd in Kvadrat Divina MD 213 on oak frame, Kaiak with arms upholstered in Kvadrat Divina MD 673 on black stained oak frame and Kaiak Lounge Spin Wood with arms upholstered in Kvadrat Divina MD 873 on black stained oak frame.



Kaiak Spin with seat upholstered in Kvadrat Divina MD 453 on RAL 9005 Black frame and Kaiak Spin Wood with seat upholstered in Kvadrat Divina MD 213 on oak frame.

32



33

Kaiak Lounge Spin Wood upholstered in Divina MD 453 on black stained oak frame and Kaiak Spin Wood Seat in Kvadrat Divina MD 213 on oak frame.

34



## Kaiak Spin Wood

The Kaiak Spin Wood chair features a fixed oak wooden leg perfect to complete the Kaiak and Kaiak Lounge collections. Its warm and comfortable look is suitable for several environments, in combination with wooden or upholstered shells.

*La silla Kaiak Spin Wood incorpora un pie fijo de madera de roble que la hacen ideal para completar las colecciones Kaiak y Kaiak Lounge. Su aspecto cálido y cómodo es adecuado para entornos distintos, sea en combinación de carcasas de madera o tapizados.*

### Products

Kaiak spin wood

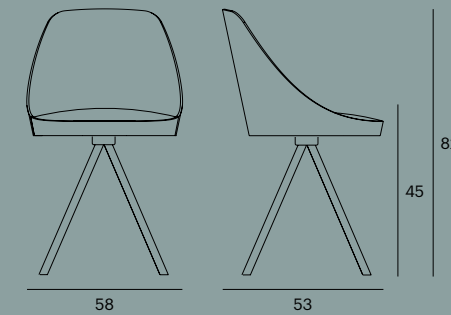

Kaiak spin wood with arms

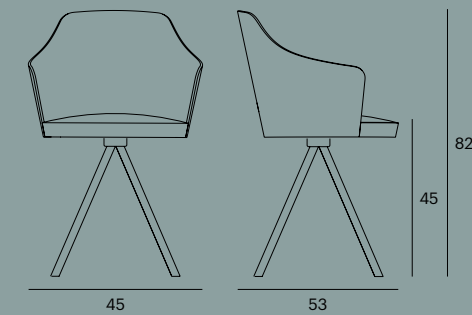

Kaiak Lounge spin wood

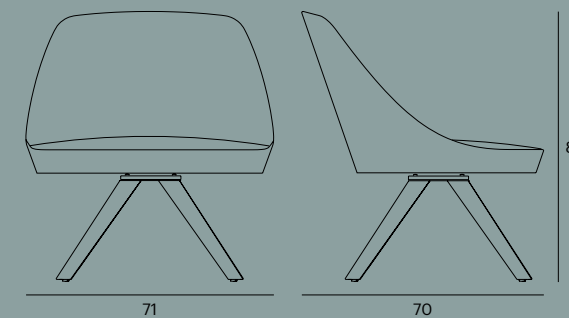

Kaiak Lounge spin wood with arms

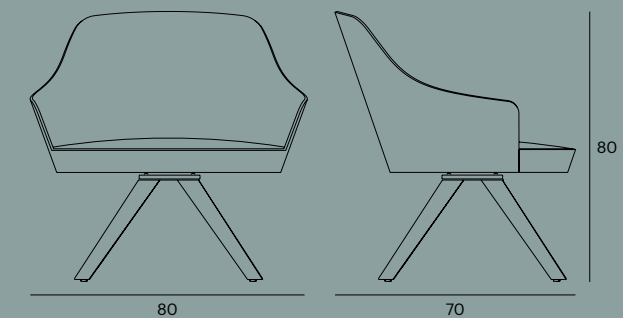

35

### Shell

- FSC-certified laminated oak wood veneer with recyclable polypropylene with foam union seat pad
- Upholstered in all materials on recyclable foam

### Carcasa

- Madera roble de chapa laminada con certificado FSC con union asiento pad de polipropileno y espuma reciclable
- Tapizable en todos los materiales en espuma reciclable

### Frame

- FSC-certified oak wood on cast aluminium union

### Estructura

- Madera roble certificado FSC en unión de aluminio inyectado

### Accessories

- Filter feets

### Accesorios

- Pies de fieltro

### Certificates

- Satisfactory results according norm UNE-EN 16139:2013
- Laminated veneer and wood in oak with FSC certificate
- Optional varnish for fireproof
- Fabrics/leathers materials: check materials' technical characteristics

### Certificados

- Resultados satisfactorios según norma UNE-EN 16139:2013
- Chapa laminada y madera roble con certificado FSC
- Opcional barnizado ignifugo
- Telas/cueros: Chequear especificaciones técnicas de materiales

### Weight-volume

Product	Weight	Volume	Units/Box	Weight/Box	Units Stackable	Units/Trolley	Heat Load
Kaiak spin wood	5.8 kg	65×48×100 cm	1	6.4 kg	-	-	135.66 MJ
Kaiak spin wood with arms	6.1 kg	65×48×100 cm	1	6.7 kg	-	-	142.04 MJ

# Ema

36

Lievore Altherr Molina

The Ema family continues growing with two new updates: an upholstered pad and a universal linking device. The pad is very useful for multipurpose or crowded spaces, improving stacking by causing less friction than the full upholstery version. The linking is an intuitive and easy-to-use part, valid for all versions of the family. Its versatility and functionality make the Ema family the best choice for all contract environments.

*La familia Ema sigue creciendo con dos nuevas actualizaciones: un pad tapizado y un conector universal. El pad es muy útil para espacios polivalentes o de mucho público, mejorando el apilado al causar menos fricción que la versión de tapicería completa. El conector es una pieza intuitiva y de fácil uso, válida para todas las versiones de la familia. Su versatilidad y funcionalidad hacen de la familia Ema la mejor opción para todos los entornos contract.*



37



In both pictures: Ema 4L Pantone 5753 on Olive frame. Ema with seat pad and back upholstered in Gabriel Chili 61174 on sled with arms frame in Pantone 4975 Wine. Ema with seat pad and back upholstered in Gabriel Swing 52005 on sled frame Pantone 174 Teja. Ema 4L with seat pad upholstered in Gabriel Chili 60081 with back and frame in RAL 7016 Anthracite.





## Ema

The new features of the Ema collection make it the best solution for crowded and multipurpose spaces. The pad improves the stacking by causing less friction than the full upholstery version, allowing the stacking up to 15 chair and 5 stools on the floor and 20 units on the transport and storage trolley. The pad is combinable with polypropylene or upholstered back. The linking is a intuitive and easy-to-use component, good for all versions of the family, that allows to link and lock chair rows.

*Las nuevas prestaciones de la silla Ema la hacen idónea para espacios polivalentes y concurridos. El pad mejora el apilamiento al causar menos fricción que la versión con tapicería completa, permitiendo el apilamiento de hasta 15 sillas y 5 taburetes en el suelo y hasta 20 unidades en el carro de transporte y almacenamiento. El pad es combinable tanto con respaldo en polipropileno como tapizado. El conector es una pieza intuitiva y fácil de usar, válida para todas las versiones de la familia y que permite unir y fijar filas de sillas.*

### Products

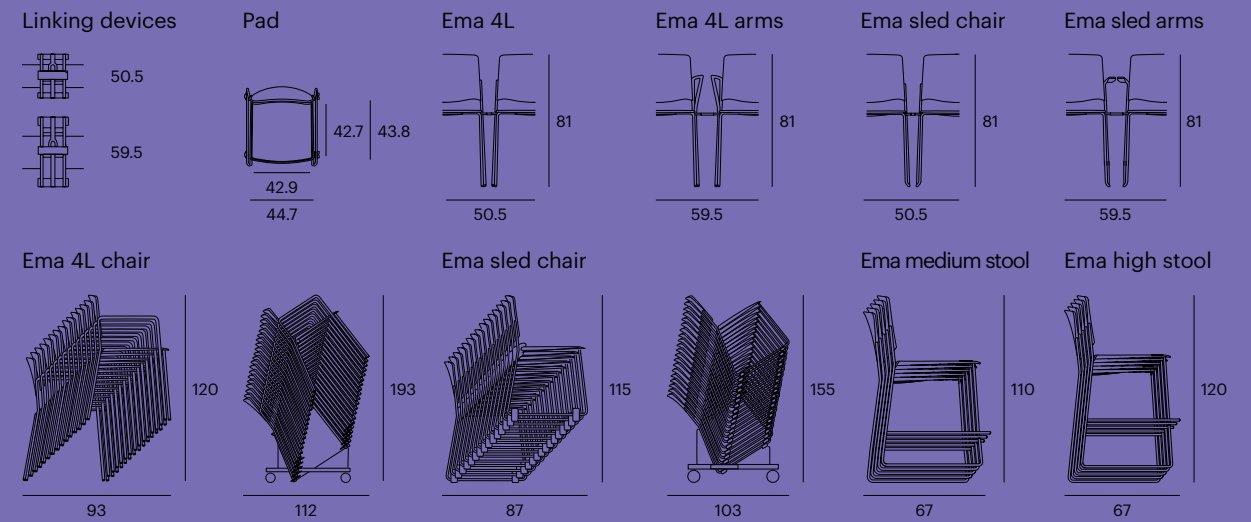

### Seat-backrest

- Recyclable polypropylene
- Upholstered seat pad in all materials on recyclable foam

### Asiento-respaldo

- Polipropileno reciclable
- Asiento pad tapizable en todos los materiales en espuma reciclable

### Frame

- Sled and 4 legs steel tube with/without arms

### Estructura

- Estructura de patin y 4 patas con/sin brazos

### Accessories

- Filter feets

### Accesorios

- Pies de fieltro

### Certificates

- Satisfactory results according norm UNE-EN 16139:2013
- Optional fireproof polypropylene according norm M2
- Optional ultraviolet polypropylene additive for outdoor
- Fabrics/leathers: check materials' technical characteristics

### Certificados

- Resultados satisfactorios según norma UNE-EN 16139:2013
- Opcional polipropileno ignífugo según norma M2
- Opcional polipropileno ultravioleta para exterior
- Telas/cueros: chequear especificaciones técnicas de materiales

### Weight-volume

Product	Weight	Volume	Units/Box	Weight/Box	Units Stackable	Units/Trolley	Heat Load
Ema sled with seat pad	4.6 kg	65×48.6×100 cm	3	14.4 kg	15	20	121.93 MJ
Ema sled with arms with seat pad	5.1 kg	65×56.6×95 cm	3	15.9 kg	15	20	122.43 MJ
Ema 4L with pad	4.75 kg	65×48.6×100 cm	3	14.85 kg	15	20	122.45 MJ
Ema 4L with arms with pad	5.9 kg	65×56.6×95 cm	3	18.3 kg	15	20	124.35 MJ
Ema sled medium stool with pad	6.6 kg	65×48.6×100 cm	2	13.8 kg	5	7	125.16 MJ
Ema sled high stool with pad	7 kg	65×48.6×100 cm	2	15.2 kg	5	7	126.16 MJ

# Features

44

Enea is for leisure and work spaces, for hospitality and communities, for gardens and terraces. Public, temporary or multipurpose spaces, crowded or reduced. To rest, read, eat, work, learn or attend, Enea offers features for all situations.

*Enea es para espacios de ocio y de trabajo, para hospitality y colectividades, para jardines y terrazas. Espacios públicos efímeros o polivalentes, concurridos o reducidos. Para descansar, leer, comer, trabajar, aprender o atender, Enea ofrece prestaciones para todas las situaciones.*

Contract  
Contract  
46

Soft-contract and hospitality  
*Soft-contract y hospitality*  
54

Outdoor  
Exterior  
62

Tables  
Mesas  
66



Our furniture is strong and transportable, stackable and encastrable, foldable and linkable.  
*Nuestro mobiliario es resistente y transportable, apilable y encastrable, plegable y conectable.*

46



47

Emapad upholstery chairs are transportable on a trolley with a maximum of 20 units.  
*Las sillas Ema con pad tapizado son transportables con trolley hasta un máximo de 20 unidades.*



48

Up to 15 units of the Ema 4L chairs with upholstered pad can be stacked on the floor.  
*Pueden apilarse en el suelo hasta 15 unidades de la silla Ema 4L con asiento pad tapizado.*



49

Pile tables are designed so that they can be easily encastrable.  
*Las mesas Pile están diseñadas para que puedan ser encastradas con facilidad.*



They can also be folded with a simple gesture.  
*También pueden ser plegadas con un simple gesto.*



We use sophisticated upholstery and finishes, ideal for soft contract and hospitality.  
*Empleamos tapizados y acabados sofisticados, ideales para soft contract y hospitality.*

54



55

An Ema 4L chair with arms upholstered in Gabriel Crisp 4021.  
*Una silla Ema 4L con brazos tapizado en Gabriel Crisp 4021.*



56

A Lottus Lounge High armchair upholstered in Gabriel Crisp 4761.  
*Una silla Lottus Lounge High con brazos tapizado en Gabriel Crisp 4761.*



57

The Caddy coat stand in White RAL 9016.  
*El perchero Caddy en White RAL 9016.*



58

A Puck Lounge with Blazer CUZ1R upholstery.  
Un Puck Lounge con tapicería Blazer CUZ1R.



59

A natural oak Kaiak Lounge chair with upholstered seat in Gabriel Savoy 61219.  
Una silla Kaiak Lounge de roble natural con el asiento tapizado en Gabriel Savoy 61219.



60

A natural oak Lottus Wood chair with upholstered seat in Camira Blazer CUZ2Q.  
*Una silla Lottus Wood de roble natural con el asiento tapizado en Camira Blazer CUZ2Q.*



61

The Lottus High office chair upholstered in Triple foam Gabriel Step Melange 68161.  
*La silla Lottus High office tapizada en Triple foam Gabriel Step Melange 68161.*



Some of our products are designed for outdoor use.  
*Algunos de nuestros productos están pensados para el exterior.*

62



63

A Street High stool with Sky Pantone 5435 finish.  
*Un taburete Street alto con acabado Sky Pantone 5435.*



64

A Street chair with arms with a Pile table with White RAL 9016 finish.  
*Una silla Street con brazos con una mesa Pile con acabado White RAL 9016.*



65

A Street armchair with White RAL 9016.  
*Una silla Street con brazos White RAL 9016.*

Our tables solve all kinds of needs.  
*Nuestras mesas solucionan todo tipo de necesidades.*

66



67

The LTS System table with steel legs is designed for offices or Meeting areas.  
*La mesa LTS System con patas de acero está pensada para oficinas o sales de reuniones.*





70



71

The Iron table is ideal for soft contract and hospitality environments.  
*La mesa Iron es ideal para ambientes soft contract y hospitality.*

Enea is a local business with global reach. We are constantly working to develop international clients and export all over the world. The quality of our manufacturing, design and engineering and our relationships with agents and distributors on five continents allow us to develop sustainable relationships on a global scale.

*Enea es una empresa local con alcance global. Trabajamos constantemente para llegar a clientes internacionales y exportar a todo el mundo. La calidad de nuestra fabricación, diseño e ingeniería, así como nuestros vínculos con agentes y distribuidores en los cinco continentes, nos permiten desarrollar relaciones sostenibles a escala mundial.*



It's Enea, everywhere  
*Es Enea, en cualquier lugar*

Art Direction & Graphic Design: Clase  
Photography: Salva López & Yosigo  
Set Design & Styling: Banzai Turba  
Fashion Styling: Rocik Boulalás  
Proofreading: Banzai Turba  
Prepress: La Sixtina  
Edition: April 2020

**Ola Auzoa, 4  
20250 Legorreta  
Gipuzkoa, Spain  
+34 943 806 275  
enea@eneadesign.com  
www.eneadesign.com**